



Accelerated Acid Etch for Automotive Clearcoats

A joint research project provides correlation between lab & field

Winner of the Federation of Societies for Coatings Technology (FSCT) John Gordon Best Paper Award

by: John Boisseau, Senior Development Chemist, BASF Corporation
 Donald Campbell, Group Leader, BASF Corporation
 Jeffrey Quill, Director of Technical Applications, Q-Lab Corporation
 William Wurst, Senior Project Engineer, Q-Lab Corporation
 Patrick J. Brennan, Vice President, Q-Lab Corporation

Abstract

Many attempts have been made in the past to develop a test that can predict the acid etch resistance of automotive clearcoats. Methods such as the Gradient Bar and Acid Spot are just two examples of the numerous laboratory methods used in industry today. No laboratory method currently in use correlates well with the results observed in the field. Past attempts to use accelerated weathering to replicate acid etch results have also failed to correlate.

This paper examines a new automotive acid etch test procedure developed jointly by BASF Corporation and Q-Lab Corporation.

Extensive environmental data was collected on composition and acidity of rainfall, frequency and duration of rainfall events, air and specimen temperatures. The critical test parameters identified include acidic solution, temperature, humidity, UV spectrum, radiant heating of the specimen and specimen orientation. Drawing on the field data, a simulated acid rain solution was developed, along with an exposure test cycle. An accelerated weathering device was modified to create a new model to accommodate the exposure requirements. The newly developed procedure, called the BASF Accelerated Acid Test, shows excellent correlation with field etch results. In addition to outlining the recent development work, this paper also sets the expectations for the future availability of the protocol to industry at large.

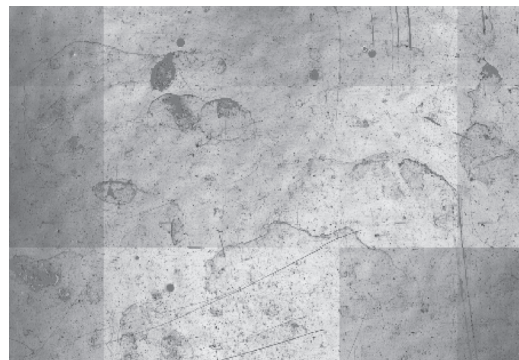

Digital image of Jacksonville outdoor test panels.

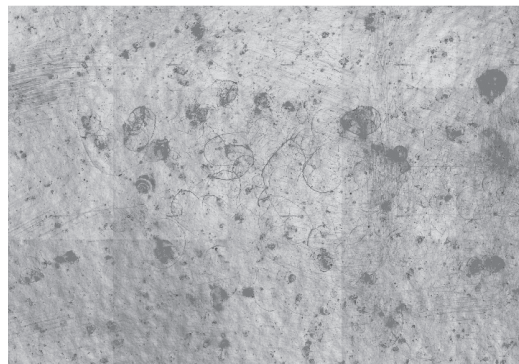

Digital image of accelerated acid test panels.

Background

In the 1980s, damage to automotive coatings from acid rain occurrences became a problem. Both dealerships and buyers complained about the ring type or “water spot” etches that were formed from the acid catalyzed hydrolysis that occurred in areas where acid rain occurred and temperatures were high.

Etches are formed when material is lost from the surface of the coating. This material is lost as a result of acid catalyzed hydrolysis of the chemical bonds within the coating. When enough bonds are broken, polymer molecules or fragments become detached from the rest of the coating, and are washed away. The lost material is greatest at the edge of water droplets where the acid concentrates during evaporation. This leads to the familiar ring or “water spot” pattern.

Most successful work on improving the acid etch resistance of automotive coatings has focused on reformulation to reduce or eliminate the acid sensitive sites within the polymer network. Most automotive coatings are comprised of a highly pigmented color coat (or basecoat), which is covered with a transparent clearcoat.

Blount Island Exposures. Summertime on Blount Island in Jacksonville, Florida was, and continues to be, one of the most severe locations in North America for the conditions that cause acid etch. As a result, this location is the site for numerous annual field tests to assess the performance of automotive coatings for acid etching resistance. Varying numbers of hoods, panels and fascia are placed in Jacksonville each year by Automotive OEMs and their suppliers. These hoods, panels and fascia vary in size and shape, but are mostly black to create the worst case scenario for etch testing. The items are exposed in a variety of ways, but are typically tested between 0 and 5 degrees horizontal. The typical testing period is approximately 14 weeks, from June to September of each year. The test specimens are rated for etch damage at varying times throughout the 14 week period using a visual method of evaluation, with standard panels used as a guide. While the Blount Island exposures have the benefit of real-world testing, there are significant limitations to the current procedure in terms of product development. In addition to the inconvenience of a single location and narrow time frame for testing, the results of this annual test vary like the weather.

Accelerated Acid Etch. Many attempts have been made to develop laboratory techniques that predict etch resistance of automotive clearcoats. There are a number of methods currently used in the industry, such as the Gradient Bar Test or the Acid Spot Test. None of these tests have included all of the field components that contribute to the etching of automotive clearcoats (humidity, UV light, specimen orientation and acidic solution).

Development of Current Procedure

BASF recognized the need for a realistic laboratory accelerated acid etch test procedure, and began to quantify the critical elements. Many of the critical test parameters could be reproduced in existing xenon arc test chambers

Since the 1950s, xenon arc testers have been used to test the weatherability of coatings. These devices have attained significant popularity because they utilize a light source which, when properly filtered, provides an excellent simulation of the full spectrum of sunlight. Traditionally, these devices have a xenon light placed in the center of the chamber, with the test specimens mounted vertically on a framework. The framework revolves around the light source, like a carousel. This mechanism is often called a “rotating drum” style tester, and is available in many models, and from several manufacturers. An example is shown in Figure 1. Unfortunately, the vertical specimen mounting system means that any liquid sprayed onto the specimen tends to rapidly run off.

Recently, Q-Lab Corporation developed and introduced the Q-Sun Xenon Test Chamber. As shown in Figure 2, the Q-Sun has xenon lamps positioned at the top of the exposure chamber, with the test parts and panels underneath the lamps. Test specimens are positioned in a near-horizontal orientation. This has several design advantages. Specifically, any liquid sprayed onto the specimens tends to remain for an extended time. Instead of quickly running off, as it does on the older rotating drum style xenon tester, it slowly dries in place.

BASF scientists recognized that this flat-array xenon would be particularly useful for reproducing the acid rain effects seen on horizontal specimens in Jacksonville. Because of Q-Lab’s experience in weathering science, correlation studies and tester design, BASF partnered with Q-Lab to embark on a joint research project to develop a realistic accelerated acid etch test procedure.

Figure 1

Xenon Test Chamber Configurations

Rotating Drum Schematic

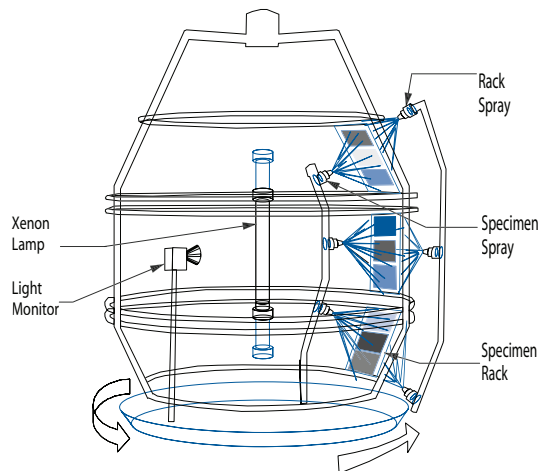

With the rotating drum style tester, the vertical specimen mounting system means any liquid sprayed onto the specimen tends to rapidly run off.

Figure 2

Xenon Test Chamber Configurations

Flat-Array Schematic

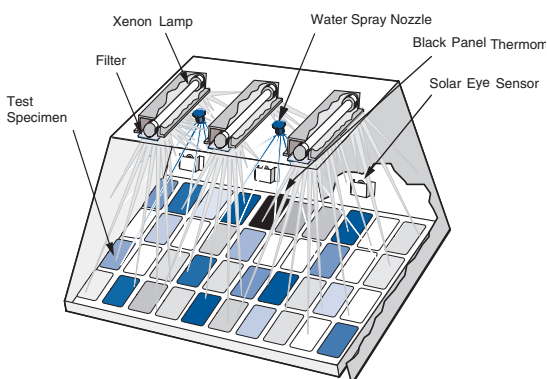

BASF Scientists recognized that with the Q-Sun’s flat-array, liquid sprayed onto the specimens tends to remain for an extended time.

¹ For a full comparison of the two different approaches to xenon arc chamber construction, see Brennan et al, 2003.

Quantifying the Exposure Environment

BASF has been monitoring the exposure conditions at the Jacksonville, Florida exposure site for a number of years. Based on that data, the following are the critical environmental conditions which were considered in the development of the new BASF Accelerated Acid Test procedure.

Temperature. Early on, BASF recognized the importance of the effect of temperature on the Jacksonville field exposure results. Consequently, temperature parameters were quantified by taking real time measurements of the actual specimens exposed in Jacksonville, which are shown in Table 1. In 1993, thermocouple measurements produced specimen temperatures as high as 80°C. In 2002, Jacksonville pyrometer measurements of actual parts and test panels (under field conditions) show the maximum specimen temperatures to be approximately 72°C.

Table 1

Jacksonville Specimen Temperatures		
All parts painted with black basecoat/clearcoat system. Approximate maximum temperatures.		
Maximum Temperature	Pyrometer 2002	Thermocouple 1993
Steel Hood	72°C	80°C
Steel Panel	63°C	74°C
Rim Panel/Fascia	58°F	69°F

As a result of this data, 80°C was chosen as the target Uninsulated Black Panel 2 temperature for the light exposure step of the Q-Sun test.

Rainfall. BASF scientists identified the necessity to use a simulated rain solution with a specific pH and chemical composition known to produce etch in Jacksonville. Field observations indicated that trace rainfall of less than 0.25 cm (< 0.1 inch) and low cloud cover, are the conditions most responsible for producing acid etch in Jacksonville. Studies determined that lower pH rainfalls are the most responsible for producing etch (e.g., 3.49 pH collected in Jacksonville in 1989).

The Jacksonville weather data in Table 2 indicates that between June and August, there are an average of 10-15 days of this type every year.

Table 2

Days with <0.25 cm rain from 11 a.m. to 4 p.m.				
Year	June	July	August	Total
2000	9	3	3	15
2001	7	4	2	13
2002	5	3	2	10

The pH and chemical composition of the simulated acid rain solution used for the accelerated laboratory method was based on an analysis of actual Jacksonville rain samples.

² For a definition of an Uninsulated Black Panel Thermometer, see ASTM G151.

Humidity and Wet Time. BASF research indicated a need to maintain a Relative Humidity that was consistent with Jacksonville’s natural exposure environment. This would best mimic the prolonged dry-off seen in the field. Jacksonville weather data shows that the Relative Humidity averages approximately 80% during the summer months (June-August).

Time of wetness (TOW) research in Florida and other locations indicates that test specimens are wet more than 50% of the time, and that the source of this wetness is dew (Grossman, 1978). Field observations in Jacksonville confirmed this, because on most summer evenings, dew formed on the parts and panels. Typically, the dew was still in place the following morning.

Therefore, in the lab simulation, a series of pure water sprays during the Q-Sun's dark step are used to simulate the evening dew. At the same time, a high humidity of 80% is maintained throughout the test to simulate the summer conditions in Jacksonville.

Specimen Orientation. Panels and parts exposed outdoors in Jacksonville are positioned at the horizontal or near-horizontal orientation angles that give severe etch effect. Typically, the most severe etching is observed at a 0 to 5 degree exposure.

To reproduce the most severe field exposure conditions, the accelerated test in the Q-Sun required the chamber to be modified in order to orient the test specimens at 0 degrees. This is a modification from the normal Q-Sun exposure angle of 10 degrees.

UV Light. Q-Panel’s experience dictated that for the best correlation to outdoor results, the lab specimens should be exposed to UV light with a similar Spectral Power Distribution (SPD) and intensity to that which is seen in the field. Q-Panel research on sunlight spectrum shows that, although the spectrum of daylight changes minute by minute throughout the day (see Figure 3), the peak noon summer sunlight solar maximum is approximately 0.68 W/m²/nm @340 nm. Q-Panel’s measurements are essentially in agreement with CIE 85, Table 4, and with the new SMART2 spectra currently proposed by ASTM Committee G03.

Figure 3

Solar Spectral Power Distribution Throughout the Day UV vs. Time

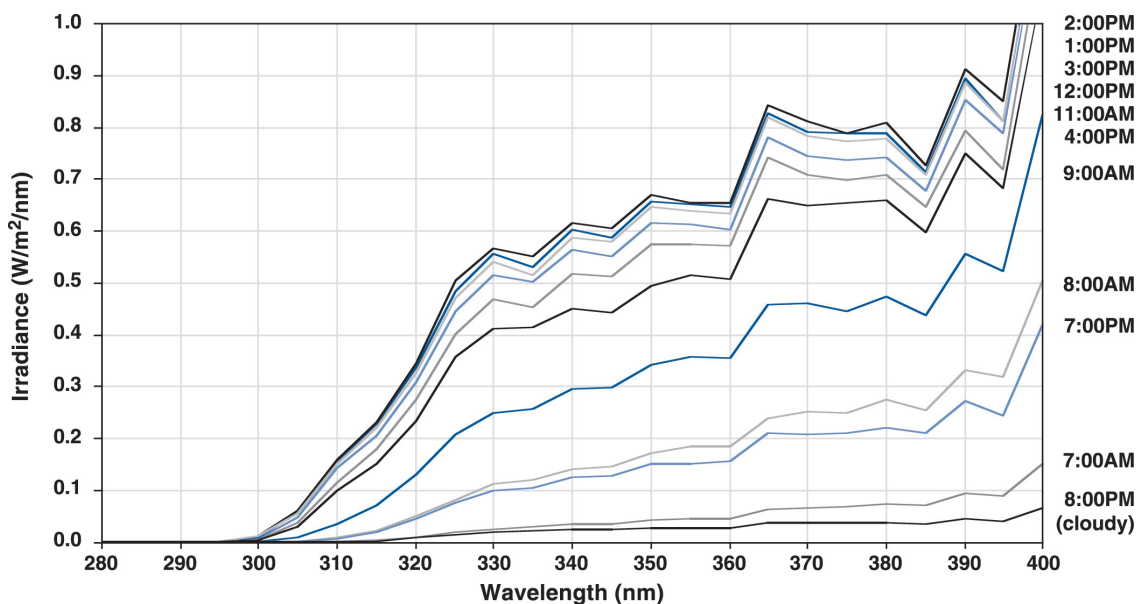

Some older automotive test methods, such as SAE J1960, use an “Extended UV” xenon spectrum to accelerate the coating degradation. This spectrum has the disadvantage of producing short wavelength UV below the solar cut-on point of 295 nm. Experience has taught us that this spectra, shown in Figure 4, can cause unnatural results for some coatings. Consequently, more recent test protocols, such as SAE J2527, allow for a more realistic spectrum by specifying the Daylight Filter described in ASTM G155. This is the same spectra specified in ISO 4892-2 and ISO 11341. The Daylight Filter spectrum, shown in Figure 5, was chosen for the new BASF Accelerated Acid Test procedure because of its close match with natural sunlight.

Figure 4
Extended UV Filters

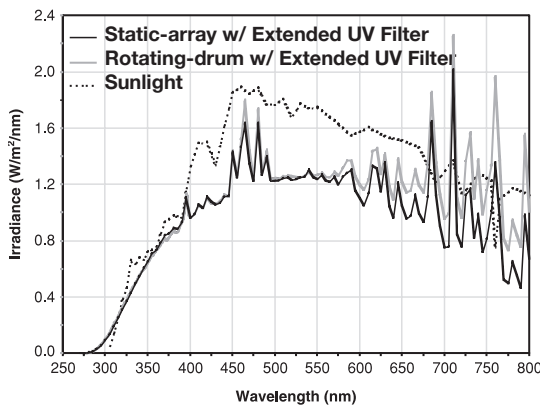

Extended UV filters are mainly used for automotive testing to accelerate coating degradation. They allow very short UV wavelengths not normally found at the earth's surface.

Figure 5
Daylight Filters and Sunlight

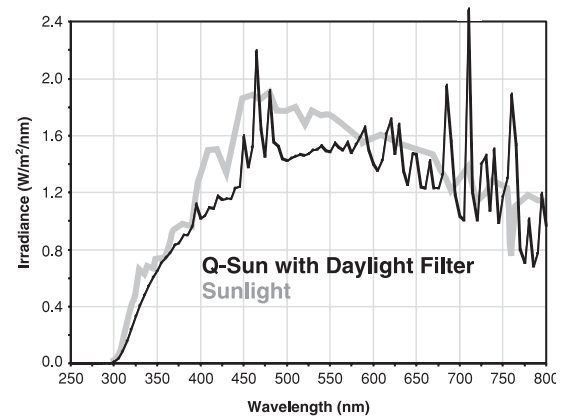

Daylight filters match the overall sunlight spectrum and the short wavelength cut on better than Extended UV filters.

Table 3

Summary of Properties		
Property	Field Observations	BASF/Q-Sun Technique
Temperature	70-80°C	80°C
Rainfall	10-15 Significant Events lowest pH 3.5	13 Acid Spray Events pH of 3.4
Dew	Evening Dew	Dark Step Water Spray
Relative Humidity	Typically 80% or Higher	80% Throughout the Test
Orientation	0 - 5 Degrees	0 Degrees
UV Light Spectrum	Variable Throughout the Day	Noon Summer Sunlight
UV Light Intensity	Variable Throughout the Day 0-0.68 W/m²/nm @340 nm	Constant 0.55 W/m²/nm @340 nm

Experimental Development

BASF developed a simulated acid rain solution which was based on the observed acid rain chemistry in Jacksonville. BASF also provided Q-Lab an initial set of test specimens coated with 4 types of clearcoat systems.

The Q-Sun Xenon Test Chamber was modified into a new model to incorporate the features dictated by field observations. A 0° specimen mounting plane and a dual spray system were added. The dual spray system can be programmed to automatically spray pure DI water and a solution in addition to and separate from the DI water, such as a simulated acid rain solution.

Using the modified Q-Sun test chamber, Q-Lab experimented with various test cycles, including 100% light, with intermittent acid spray. Table 3 on the previous page gives a summary of the properties of field observations and the accelerated technique. Q-Lab determined that a cycle with both a light and a dark time exposure gave better correlation to the outdoor etch results from Jacksonville. The volume and frequency of acid spray was adjusted to best simulate the outdoor results. After some Edisonian Research, an optimized exposure cycle was developed, which is shown in Table 4. After the cycle was determined, the test specimens were exposed in the Q-Sun and evaluated at intervals of 200, 300, 400, 500, 600, and 700 hours.

Table 4

BASF Accelerated Acid Test Exposure Cycle		
Step 1	1 minute	Dark Exposure; with Acid Rain Spray
Step 2	3 hrs 50 minutes	Dark Exposure; 38°C B. P. Temperature; 38°C Chamber Air Temperature; 80% RH
Step 3	12 hrs	Light Exposure; 0.55 W/m ² /nm @ 340 nm; Daylight Filters; 80°C Black Panel Temperature; 55°C Chamber Air Temperature; 80% RH
Step 4	27 minutes	Dark Exposure; 38°C B. P. Temperature; 38°C Chamber Air Temperature; 80% RH
Step 5	1 minute	Dark Exposure; with Pure Water (DI) Spray
Step 6	3 hrs 50 minutes	Dark Exposure; 38°C B. P. Temperature; 38°C Chamber Air Temperature; 80% RH
Step 7	1 minute	Dark Exposure; with Pure Water (DI) Spray
Step 8	3 hrs 50 minutes	Dark Exposure; 38°C B. P. Temperature; 38°C Chamber Air Temperature; 80% RH
Step 9	Begin again at Step 1	

Acid Etch Evaluation Procedure

The evaluation of acid damage was performed visually, and the test specimen were rated on a scale from 0 (best) to 10 (worst). A summary of the rating scale is given in Table 5.

Table 5

Rating	Description
0 a 3	The etch would be very slight and only noticed by a trained observer
4 a 6	The etch would be slight to moderate and in some cases noted by a vehicle owner (untrained observer)
7 a 10	The etch is severe enough that many vehicle owners would notice and complain

For certain tests, the scale was extended to allow for finer discrimination.

Exposure Results Compared

Jacksonville Data. Data from two years of Jacksonville natural exposures was compared to establish a baseline. As expected, there were differences from year to year in the absolute values. However, there was perfect agreement in the rank order of the various systems from year to year. See Table 6 and Figure 6.

Table 6

Jacksonville Acid Etch Data		
Visual Evaluation Ratings		
Coating System	Rating 2001	Rating 2002
A	4	5.5
B	5	7.5
C	7	10
D	11	14

Figure 6

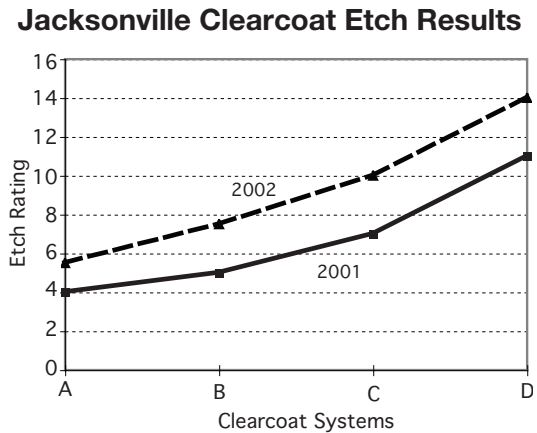

Data from Jacksonville natural exposures shows fluctuations in etch ratings from year to year.

BASF Accelerated Acid Test Results. The test specimens were rated at 100 hour intervals, beginning at 200 hours. The results are shown in Table 7 and Figure 7. After 200 hours in the Q-Sun, the relative rank order was well established, and remained unchanged throughout the exposure period.

The BASF Accelerated Acid Test results were compared to actual Jacksonville natural exposure data. As shown in the figures, after only 200 hours in the Q-Sun, the BASF Accelerated Acid Test procedure gave the same ranking as the Jacksonville exposures. After 400 hours, it produced both the correct Spearman rank order ($\rho = 1.0$) and approximately the same level of etching as seen after 14 weeks of the 2001 Jacksonville exposure (Figures 8 & 9). After 700 hours, the BASF Accelerated Acid Test results were the essentially identical to 2002 Jacksonville data (Figure 10).

Table 7

BASF/Q-Sun Results						
Visual Evaluation Ratings						
System	200 hrs	300 hrs	400 hrs	500 hrs	600 hrs	700 hrs
A	3	3	3	4	4	5
B	4	4	6	7	7	8
C	6	5	7	8	8	10
D	9	9	11	12	13	14

Figure 7

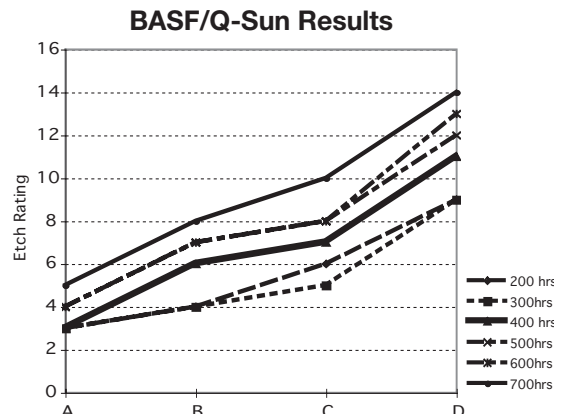

The BASF Accelerated Acid Test results were comparable to actual Jacksonville natural exposures.

Figure 8

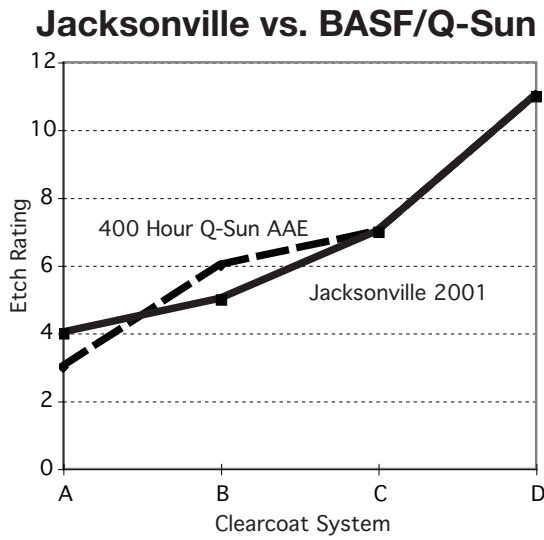
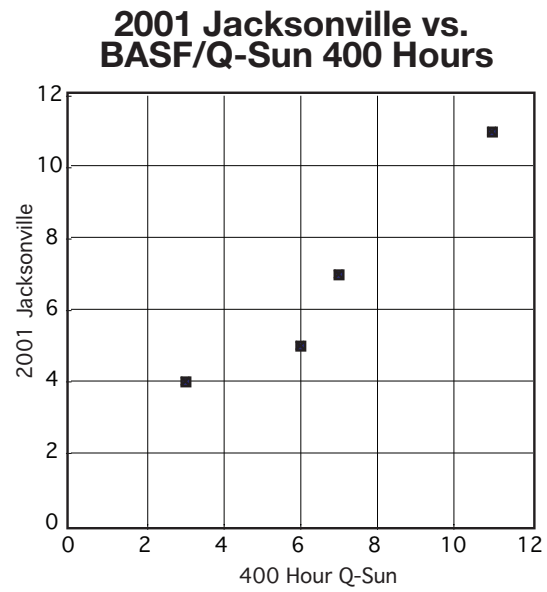
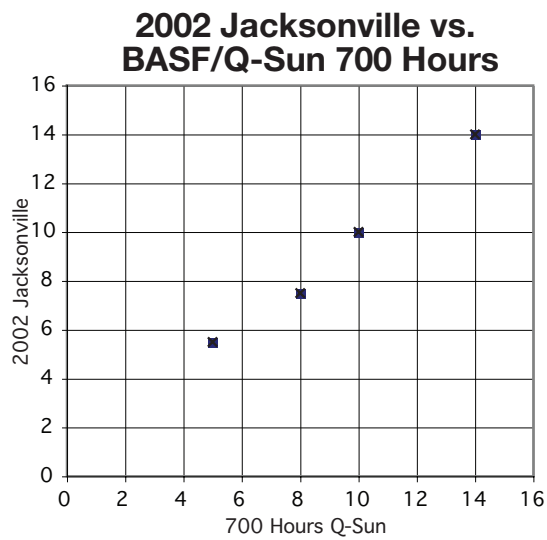

Figure 9



After 400 hours, the BASF Accelerated Acid Test produced the same level of etching as seen after 14 weeks of Jacksonville outdoor exposure.

Figure 10



After 700 hours, the BASF Accelerated Acid Test produced etching nearly identical to outdoor exposures.

Expanded Testing. Because of the excellent results, the test was expanded to include more clearcoat systems for which Jacksonville data was already available. To establish a benchmark, the Jacksonville 2001 and 2002 data were compared using both Pearson and Spearman correlation methods. For data of this type, the authors believe that Pearson's method is more useful. The data sets exhibited a Pearson's correlation coefficient of 0.88 and a Spearman rank order coefficient of 0.72.

The same systems were exposed for 420 hours to the BASF Accelerated Acid Test procedure. The Q-Sun results agreed with the 2001 Jacksonville results with an Pearson's correlation of 0.90 and a Spearman's rank order coefficient of 0.80.

When the BASF Accelerated Acid Test ratings were compared to the average of the 2001 and 2002 Jacksonville results, the correlation was even better. Pearson $R^2 = 0.93$ and Spearman $\rho = 0.80$. In short, the BASF Accelerated Acid Test results agreed with Jacksonville as well as, or better than, Jacksonville agreed with itself.

Table 8

Jacksonville Ratings vs. BASF/Q-Sun

Clearcoat System	420 hr Q-Sun Rating	2001 Jacksonville Rating
1	5	5
2	5	6
3	6	4
4	6	5
5	6	6
6	8	6
7	10	9
8	10	10
9	10	10

Table 9

Jacksonville '01 & '02 Data vs. BASF/Q-Sun

Clearcoat System	420 hr Q-Sun Rating	2001-2002 Jacksonville Average Rating
1	5	5
2	5	5
3	6	5
4	6	6
5	8	6
6	6	6
7	6	6
8	6	7
9	10	10
10	9	10
11	10	10
12	10	10

Summary & Conclusions

A new BASF Accelerated Acid Test procedure for the Q-Sun was developed jointly by BASF and Q-Lab Corporation. The procedure identified and incorporated all of the known critical test parameters. In order to accomplish this, BASF developed a simulated acid rain solution and Q-Panel modified the Q-Sun Xenon Test Chamber. Correlation between the new procedure and the Jacksonville natural exposures are better than, or equal to, the correlation between Jacksonville's year to year results.

The development of the new procedure has a number of significant benefits to industry:

1. It allows for faster development of etch-resistant coatings. As many as 20 iterations per year of formulate/test/reformulate vs. current 1 iteration per year, as dictated by natural Jacksonville exposures.
2. The relatively pristine condition of specimens tested in the lab allows for the use of digital evaluation of etches. The Jacksonville panels cannot practically use this technique due to scratches, dirt, etc.
3. It is expected that this BASF Accelerated Acid Etch Test can be used to simulate other acid rain environments, where the rain chemistry differs from Jacksonville.
4. The new procedure allows the possibility of consistent monitoring of assembly plant systems for etch as an "early warning system."
5. Ultimately, because of the new BASF Accelerated Acid Etch Test procedure, there should be fewer acid etch failures in service

Acknowledgements

The authors would like to acknowledge the following contributors to the BASF Accelerated Acid Test development:

BASF Corporation	Q-Lab Corporation
P. Deskovitz	D. Fayak
L. Pattison	G. Fedor
T. Richards	D. Grossman
H. Valatka	J. Quill
	R. Roberts

References

- ASTM G151, Standard Practice for Exposing Nonmetallic Materials in Accelerated Test Devices that Use Laboratory Light Sources.
- ASTM G155, Standard Practice for Operating Xenon Arc Light Apparatus for Exposure of Nonmetallic Materials.
- Brennan, P. J., Static and Rotating Xenon Arc Exposures Compared: technical issues, practical considerations, & how different types of hardware comply to the new performance-based test methods. 1st European Weathering Symposium. Prague, Czech Republic.
- CIE 85, Table 4. Publication Number 85: 1989, Technical Report - Solar Spectral Irradiance.
- Grossman, P. R., Investigation of Atmospheric Exposure Factors that Determine Time-of-Wetness of Outdoor Structures, in Atmospheric Factors Affecting the Corrosion of Engineering Materials, ASTM STP 646, Coburn, S. K., Ed., American Society of Testing and Materials, 1978
- ISO 11341, Paints and varnishes - Artificial weathering and exposure to artificial radiation - Exposure to filtered xenon- arc radiation.
- ISO 4892-2, Plastics - Methods of exposure to laboratory light sources - Part 2: Xenon-arc sources.

References (continued)

SAE J1960, Accelerated Exposure of Automotive Exterior Material Using a Controlled Irradiance Water Cooled Xenon Arc Apparatus.

SAE J2527, Accelerated Exposure of Automotive Exterior Materials Using a Controlled Irradiance Xenon Arc Apparatus.

Notes

At the time of this study and its first publication, Q-Lab Corporation was known as Q-Panel Lab Products.

A US Patent has been filed jointly by BASF Corporation and Q-Lab Corporation that covers this test method and apparatus. Under the terms of the Joint Development Agreement between BASF Corporation and Q-Lab Corporation, BASF Corporation has exclusive use of this test method until July 16th, 2005.

Q-Sun is a registered trademark of Q-Lab Corporation, 800 Canterbury Road, Cleveland OH, 44145 USA (www.q-lab.com).

The authors may be contacted at:

BASF Corporation, 26701 Telegraph Road, Southfield MI, 48034 USA
John Boisseau, Senior Development Chemist, BASF Corporation
Donald Campbell, Group Leader, BASF Corporation

Q-Lab Corporation, 800 Canterbury Road, Cleveland OH, 44145 USA
William Wurst, Senior Project Engineer, Q-Lab Corporation
Patrick J. Brennan, Vice President, Q-Lab Corporation

Test Methods are available from the following organizations:

ASTM International, 100 Barr Harbor Drive, West Conshohocken PA 19425, USA.

ISO, Case Postale 56, CH-1211 Geneve 20, Switzerland.

SAE International, 400 Commonwealth Drive, Warrendale, PA 15096, USA.

Q-Lab Corporation

**Q-Lab Headquarters
& Instruments Division**
800 Canterbury Road
Cleveland, OH 44145 USA
Phone: 440-835-8700
Fax: 440-835-8738

Q-Lab Europe
Express Trading Estate
Stonehill Road, Farnworth
Bolton, BL4 9TP England
Phone: 011-44-120-486-1616
Fax: 011-44-120-486-1617

Q-Lab China
Room 1809/1810, Liangyou Bld.
618 Shangcheng Road
Pudong District
Shanghai, China 200120
Phone: 011-86-21-5879-7970
Fax: 011-86-21-5879-7960



www.q-lab.com
info@q-panel.com

LX-5025
© 2006 Q-Lab Corporation.
All Rights Reserved.